AGATH

T2 **55** 1080p
IP65

Technical Datasheet

In-wall TV - suitable for bathroom

B&W sound



Fanless. Very simple installation process.
Suitable for on wall installation.

700 cd/m² to 1500 cd/m²
Frequency 60Hz
High Quality 24/7
Power 115w

May 2018

List of Standard Models

CONTENTS

Television set	1
Steel frame for in-wall installation	1
Remote control (LM27)	1
Waterproof remote control (LT30)	1
2 water resistant in-wall speakers	1
5 meters audio cable	1
Composite audio/video jack cable	1
YUV jack cable	1
24V adaptor with 5 metre cable	1

INCLUDED FUNCTIONS

RS232 control / IP control (option)

- Control of the main television's functions
- Volume control by direct value
- Backlight control (on or off)
- Blocking function of the remote control
- Reading of the functions status of the TV

Infra-Red relay 38 KHz

- Control of devices deported through the TV
- Can be connected to a flasher at the rear of the TV

Distinct ON/OFF signals (IR)

- 2 distinct signals to switch on and switch off the TV
(Hidden command on LM27)

DISPLAY

Screen size	55" (140 cm)
Display area (H/V) (mm)	1213 x 684
Aspect ratio	16:9
Resolution (pixels)	1920 x 1080

SPECIFICATIONS

Glass width (mm)	1400
Glass height (mm)	860
Total depth (mm)	76*
Weight with back box	57 kg
Power supply	DC 24V

PACKING

Parcel	1
Length (mm)	1350
Width (mm)	800
Height (mm)	1000
Weight	80 kg

Ports and connections : AGATH Electronic Modules

ME 3463

THE COMPLETE SOLUTION

RESIDENTIAL, HOSPITALITY, YACHTS, P.O.S, Etc

Hotel mode, USB player and inside recorder, two tuners, CI+, CEC. The ME3463 Media Module offers a multitude of ports and connections allowing you to connect easily to your regular devices.

➔ See full description on the ME3463 datasheet



DVB-T/T2
DVB-C
DVB-S2



2 HDMI



RS232
CONTROL



IP TV
COMPATIBLE

RESOLUTION

480 P (60Hz)
720 P (60Hz)
1080 I (60Hz)
1080 P (24/60Hz)



LT30

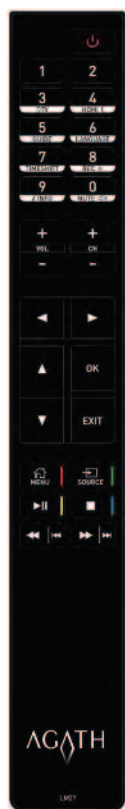

*Option
LM27



B&W
Bowers & Wilkins

BOWERS & WILKINS IN-CEILING SPEAKERS



DC 24V POWER SUPPLY:

Length (mm)	245
Width (mm)	70
Height (mm)	37

Installation Instructions

To install a television screen, you must first position the back box on the wall and mount it with the assembly kit provided.

The back box can be mounted with 2 solutions :

- using the lugs positioned of both sides on the box
- using the four holes at the bottom of the box

Once the wall back box is correctly installed, the whole screen sits on the box and is held in place by a magnetic system.

To obtain an IP65 protection rating for the front side, apply a silicon seal around the screen, thus ensuring the wall is also correctly protected.

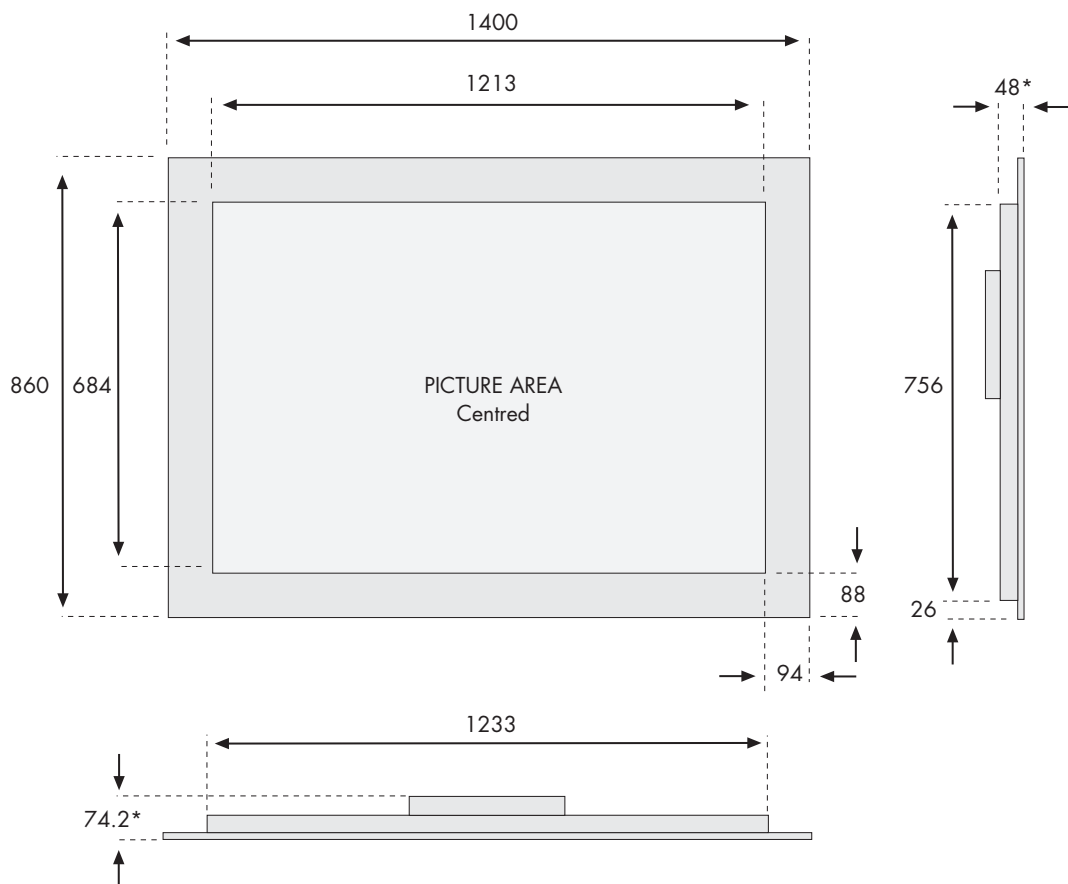

* For Super Clear and Premium glass finishes add 3mm

All dimensions have a tolerance of +/- 1 mm

Installation Instructions

SCREEN

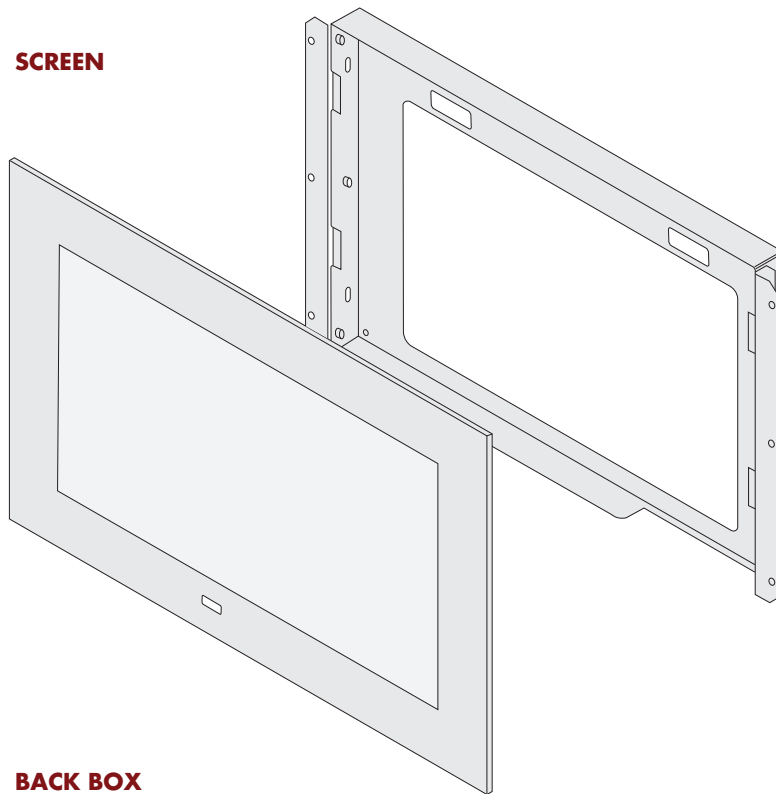

BACK BOX

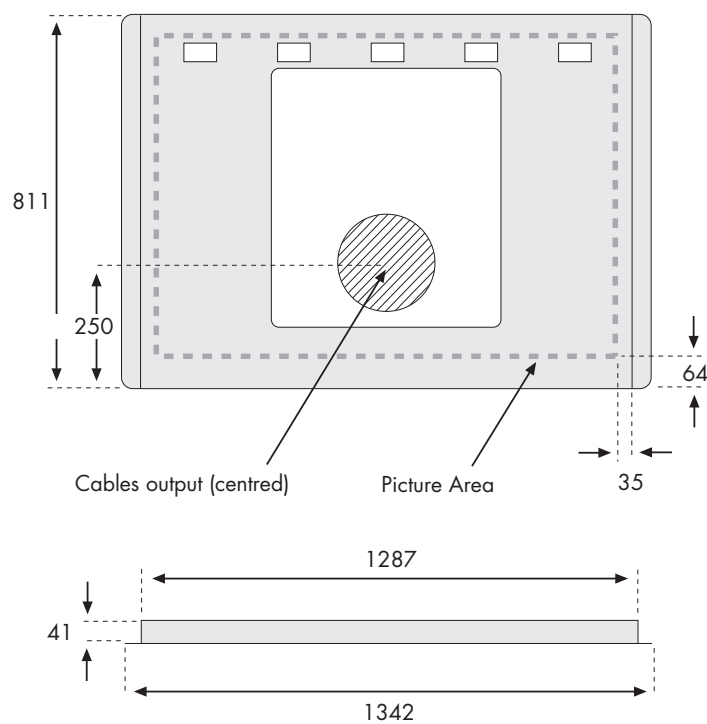

All dimensions have a tolerance of +/- 1 mm

Installation Instructions

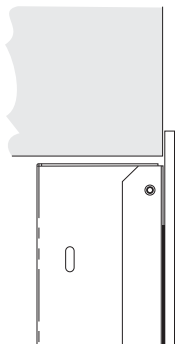

SURFACE INSTALLATION

Wall section to cut out :

Width (mm)	1391
Height (mm)	815
Minimum depth (mm)	72

CAUTION: Frame + Module

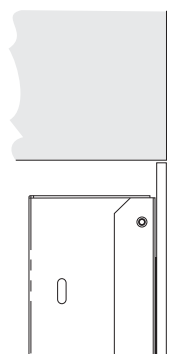

FLUSH INSTALLATION

Wall section to cut out :

Width (mm)	1404
Height (mm)	864
Depth (mm): 6mm glass	78
9mm Premium glass	81

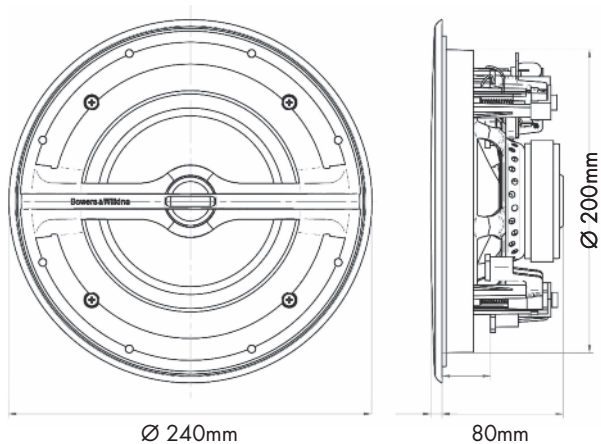

LOUD SPEAKER INSTALLATION

Wall section to cut out :

Hole diameter (mm)	200
Minimum depth (mm)	80

Options: S.E.M. (Split Electronic Module)

MD2 IN-WALL TELEVISIONS

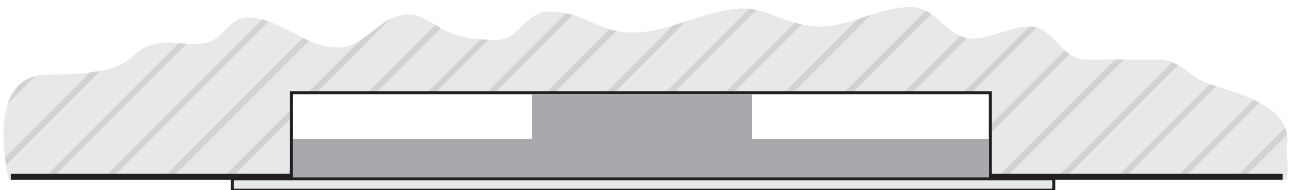

Electronic module Top View

MD2 **55**

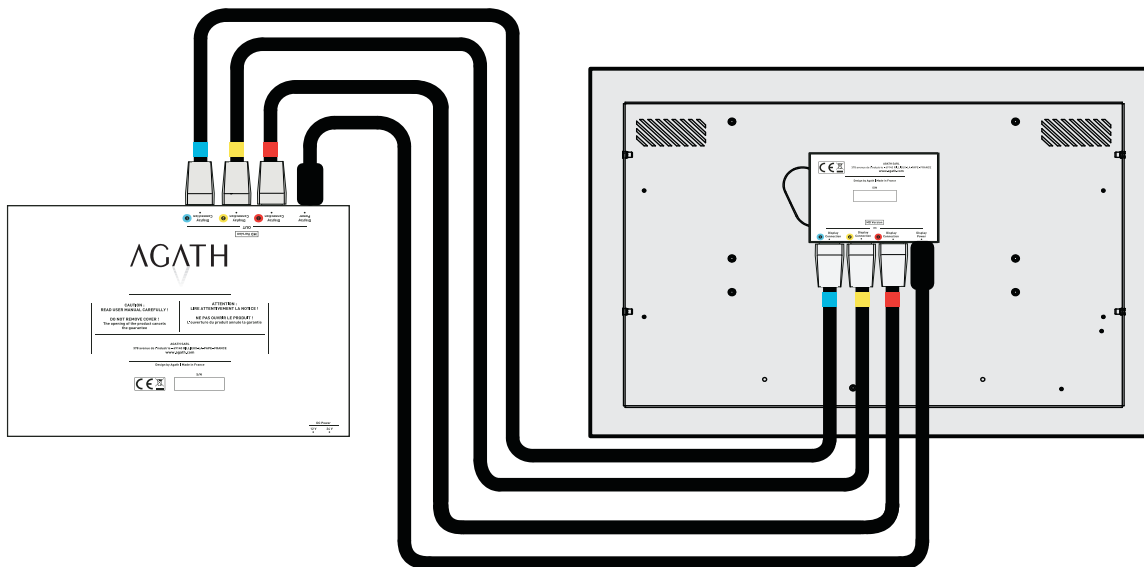

Sizes: 22" - 55" comes with 2 modules, 3 screen data cables and 1 power cable.